

# PROPOSED SMPTE ENGINEERING GUIDELINE

## Annex D (informative) Bibliography

- Federal Communications Commission §73.681, IRE Standard Scale
- NTSC 1941, Transmission Standards for Commercial Television Broadcasting
- NTSC 1953, Recommendation for Transmission Standards for Color Television

## Supplemental Information for SMPTE 170M and Background on the Development of NTSC Color Standards

SMPTE EG 1-1990, Alignment Color Bar Test Signal for Television Picture Monitors

SMPTE EG 27, Supplemental Information for SMPTE 170M and Background on the Development of NTSC Color Standards

### 1 Scope

This guideline is intended to provide supplemental and background information for SMPTE 170M, Television – Composite Analog Video Signal – NTSC for Studio Applications.

The guideline also provides information on the development of the National Television System Committee 1953 Recommendations for Transmission Standards for Color Television.

Use of this guideline will aid in the understanding and implementation of modern NTSC television signals, equipment, and practices.

### 2 NTSC chroma levels

#### 2.1 Saturated colors

The video from a live camera viewing a saturated color scene can have an upper chroma excursion of 131 IRE units. Full-level color bars are representative of such a saturated color scene.

When full-amplitude G, B, and R video signals in the form of a full-field color bar signal are present at the NTSC encoder input, the encoder composite video (N), with the two color components (I and Q or B-Y and R-Y), will be a 100% level, 7.5% setup color bar signal (see figure 1). Full-level color bars, with setup, have the video and chroma levels listed in table 1.

Each individual value in table 1 is rounded to 0.1 IRE. Note that following rounding, chroma maximum minus chroma minimum does not necessarily exactly equal the rounded value for the chroma level. The largest discrepancy is 0.1 IRE. For more precise values, see annex A of SMPTE 170M.

NOTE – Although burst is the phase reference in the NTSC signal, the subcarrier phase reference used in the encoded signal formulas and in table 1 is the phase of the color burst +180°.

#### 2.2 Clipping

In video equipment where the luminance and chrominance signals are separated for processing, white and black level clipping on the luminance (Y) portion of the signal may be employed. Other equipment may clip the composite signal. Note that any such clipping can result in a change in chrominance saturation.

### 3 Color bar signals

#### 3.1 Color bar signal amplitudes

As noted in 2.1, video from a live camera viewing a saturated color scene can have an upper chroma excursion of 131 IRE units, as represented by full-level color bars.

Properly adjusted television transmitters do not pass chroma information with an amplitude greater than 120 IRE units. Therefore, reduced amplitude color bar signals are used for transmitter testing.

NOTE – The NTSC 1953 standard assumed the use of 75% color bar signals for transmitter testing (see NTSC 1953, appendix A, clause III.D.6, reproduced in annex B of this document).

Many present-day encoders and test generators implement the SMPTE color bar test signal (SMPTE EG 1-1990), which is a reduced amplitude (75%) signal (see table 2). Some equipment also implements full-amplitude color bars (see tables 3 and 4).

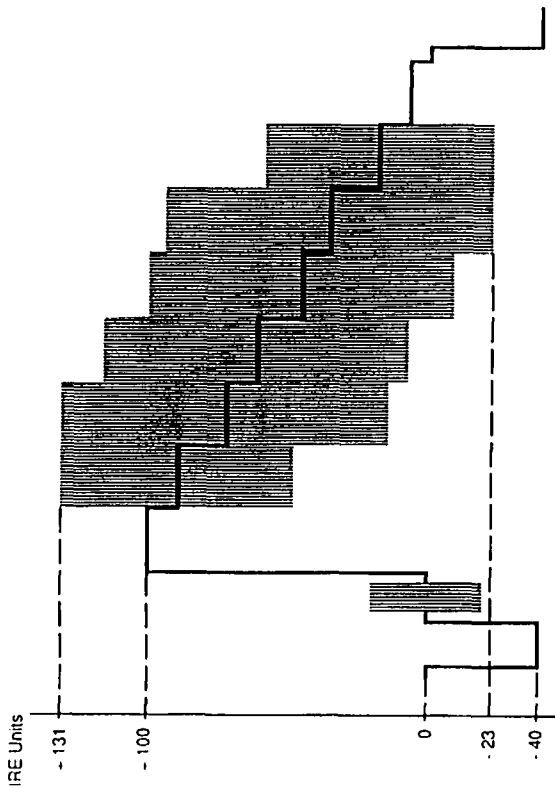

Figure 1 – Composite video signal amplitudes with two color components (full field, full amplitude color bar signal input)

Table 1 – Video and chroma levels

Bar	Luminance (IRE)	Chroma level (IRE)	Minimum chroma excursion (IRE)	Maximum chroma excursion (IRE)	Phase (degrees)
White	100.0	0.0			
Yellow	89.5	82.8	48.1	130.8	167.1
Cyan	72.3	117.0	13.9	130.8	283.5
Green	61.8	109.2	7.2	116.4	240.7
Magenta	45.7	109.2	- 8.9	100.3	60.7
Red	35.2	117.0	-23.3	93.6	103.5
Blue	18.0	82.8	-23.3	59.4	347.1
Black	7.5	0.0			
Burst	0.0	40.0	-20.0	20.0	180.0

Table 2 – SMPTE/EIA color bar test signal with setup (100/7.5/75/7.5)

Bar	Video level nominal (IRE)	Chroma level nominal (IRE)	Lower nominal	Upper nominal
White flag	100.0	0.0		
Gray	76.9	0.0		
Yellow	69.0	62.1	37.9	100.0
Cyan	56.1	87.7	12.3	100.0
Green	48.2	81.9	7.3	89.2
Magenta	36.2	81.9	- 4.8	77.1
Red	28.2	87.7	-15.6	72.1
Blue	15.4	62.1	-15.6	46.4
Black	7.5	0.0		

NOTE – When using the SMPTE color bar test signal, the upper excursion of the yellow and cyan bar chroma signals is exactly 100 IRE units.

Table 3 – Full-amplitude color bars without setup (100/0/100/0)

Bar	Video level nominal (IRE)	Chroma level nominal (IRE)	Lower nominal	Upper nominal
White	100.0	0.0		
Yellow	88.6	89.5	43.9	133.3
Cyan	70.1	126.5	6.9	133.3
Green	56.7	118.1	-0.3	117.7
Magenta	41.3	118.1	-17.7	100.3
Red	29.9	126.5	-33.3	93.2
Blue	11.4	89.5	-33.3	56.1
Black	0.0	0.0		

NOTE – When using a full amplitude color bar signal (with or without setup), the upper excursion of the magenta bar chroma is approximately 100 IRE units.

Table 4 – Full-amplitude color bars with setup (100/7.5/100/7.5)

Bar	Video level nominal (IRE)	Chroma level nominal (IRE)	Lower nominal	Upper nominal
White	100.0	0.0		
Yellow	89.5	82.8	48.1	130.8
Cyan	72.3	117.0	13.9	130.8
Green	61.8	109.2	7.2	116.4
Magenta	45.7	109.2	- 8.9	100.3
Red	35.2	117.0	-23.3	93.6
Blue	18.0	82.8	-23.3	59.4
Black	7.5	0.0		

NOTE – When using a full amplitude color bar signal (with or without setup), the upper excursion of the magenta bar chroma is approximately 100 IRE units.

video signals into Y, R-Y, and B-Y. The second matrix encoded R-Y and B-Y into I and Q.

The NTSC 1953 standard also called for the I and Q signals to be bandwidth limited as follows:

- I signal less than 2 dB down at 1.3 MHz at least 20 dB down at 3.6 MHz
- Q signal at 0.4 MHz less than 2 dB down at 0.5 MHz less than 6 dB down at 0.6 MHz at least 6 dB down

4.2 Standard practice NTSC encoder

Most equipment manufacturers implement the NTSC signal using a single matrix to encode the gamma-corrected green (G), blue (B), and red (R) video signals directly into the color-difference signals (see figure 3).

The low-pass filters (LPF) in the I and Q color-difference paths cause signal delay. The Q signal 0.5 MHz LPF causes more delay than the I signal 1.3 MHz LPF. This requires the use of a delay line (DL) in the I color-difference signal and a longer delay line in the luminance (Y) signal. (Any filtering of the color-difference signals requires a delay line in the luminance [Y] signal.)

When this signal is transmitted, a low-pass filter in the transmitter bandwidth limits the luminance (Y) signal and the upper sideband of the I signal to 4.2 MHz. Some equipment manufacturers include a low-pass filter in their encoders to bandwidth limit the

3.2 Different color bar signals  
Although the NTSC 1953 recommendation clearly called for the use of setup on all signals (see NTSC 1953, appendix A, clause III.C.2, reproduced in annex B of this document), some equipment manufacturers implement full-amplitude color bars with setup and others without setup (see tables 3 and 4).

Some manufacturers implement full-amplitude color bar signals as full-field signals, while others use split fields with both the color bars and the reference white bar (sometimes called white flag) at full amplitude. As a result, there are different color bar signals that have been in common use over the years.

NOTE - The different color bar signals are described by four amplitudes separated by slashes. The amplitudes are all expressed in percent. The first number is the reference white bar amplitude. The second number is the reference black bar amplitude. The third number is the white amplitude from which the color bars are derived. The fourth number is the black amplitude from which the color bars are derived. For example, 100/0/75/7.5 bars would be 75% bars with 7.5% setup in which the white bar has been set to 100% and the black bar is set to 0%.

4 Comparison of NTSC (1953) and equal-bandwidth NTSC encoders

4.1 NTSC (1953) encoder

The 1953 National Television System Committee (NTSC) specifications called for the use of two matrices (see figure 2). The first matrix encoded the gamma-corrected green (G), blue (B), and red (R)

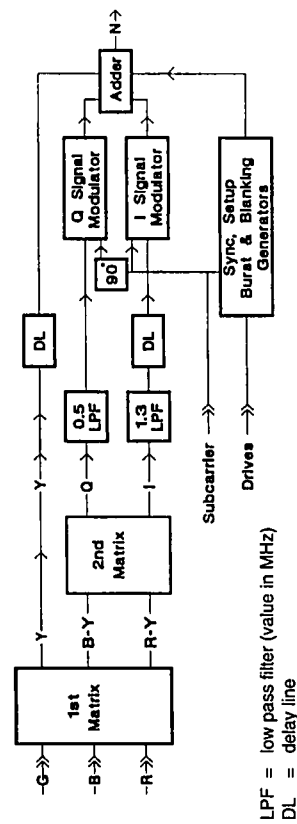
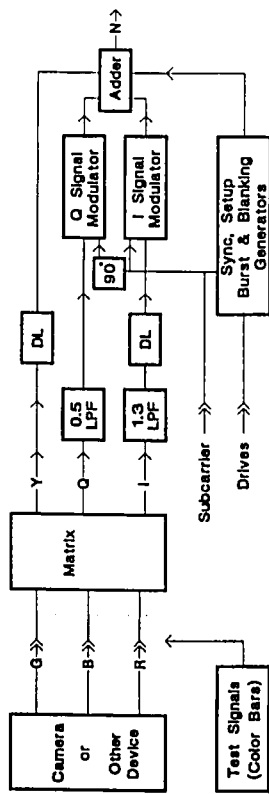

Figure 2 - Original NTSC two-matrix encoder

LPF = low pass filter (value in MHz)  
DL = delay line



LPF = low pass filter (value in MHz)  
DL = delay line

Figure 3 - Standard practice NTSC single-matrix encoder

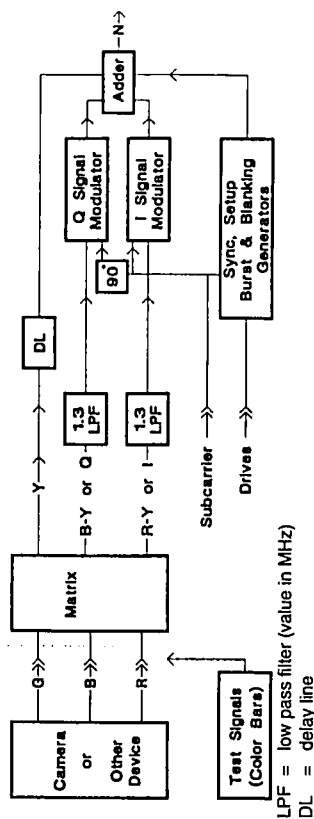

Figure 4 - Equal-bandwidth NTSC encoder

luminance (Y) signal and the upper sidebands of the color-difference signals (either B-Y and R-Y or I and Q) to 4.2 MHz.

4.3 Equal-bandwidth NTSC encoder

The NTSC encoder described in SMPTE 170M uses equal-bandwidth color-difference signals (either B-Y and R-Y or I and Q). This removes the need for a delay line in the color-difference signal. A shorter delay line than required for NTSC 1953 is used in the luminance (Y) signal (see figure 4).

When this signal is transmitted, a low-pass filter in the transmitter bandwidth limits the luminance (Y) signal and the upper sidebands of the color-difference signals (either B-Y and R-Y or I and Q) to 4.2 MHz. Transmission of equal-bandwidth color-difference signals to the receiver has the effect of limiting the recoverable chroma bandwidth to 0.6 MHz as a result of the truncation of the upper sidebands of the chroma modulation in the transmitter's 4.2 MHz filter. This is considered acceptable since there are no modern receivers that utilize the theoretically possible wide-band 1 demodulation made possible by maintaining

narrow-band Q. If it is desired to transmit equal-bandwidth encoded NTSC signals and permit recovery of the wide-band I, it is necessary to decode and re-encode with the appropriate narrow-band Q channel filler prior to transmission.

## 5 Background on NTSC, EIA, and SMPTE committees

### 5.1 Black-and-white TV and NTSC-1

The first National Television System Committee (NTSC-1), started by the Radio Manufacturers Association (RMA), met during 1940 and 1941. The group's work resulted in the submission of "Transmission Standards for Commercial Television Broadcasting" to the Federal Communications Commission (FCC) at a hearing on March 20, 1941. The FCC adopted the NTSC-1 recommendations as the standards for "Monochrome Transmission Systems" in May 1941. Commercial television broadcasting began in the United States on July 1, 1941. The chairman of the first NTSC was Dr. W.R.G. Baker. The editor of papers was Donald G. Fink.

Dr. Alfred N. Goldsmith, co-founder of the Institute of Radio Engineers (IRE), headed the research on physiological and psychological factors. Peter Goldmark of CBS headed the TV systems group.

### 5.2 Color TV

In 1950, after eight months of hearings and about 10,000 pages of testimony, the FCC selected the incompatible field-sequential system for color television broadcasting. The Commission's decision was challenged in the courts, with the United States Supreme Court upholding the validity of the FCC decision on May 28, 1951.

The challenges to the field-sequential color system, both at the Commission and in the courts, were based primarily on the fact that the field-sequential color system was incompatible with the already existing black-and-white television sets. The Commission apparently felt that the talk about compatible color systems was just a way of delaying Commission action on any color television system.

On June 11, 1951, the FCC, in Public Notice 656008, stated that color television broadcasting would use the field-sequential color system until someone could

come up with a better (but not necessarily compatible) system.

### 5.3 NTSC-2

The second National Television System Committee (NTSC-2) was started during 1950 by the Radio-Television Manufacturers Association (RTMA) in hopes that the committee would be as effective as was the committee of 1940-1941. This group (which is often referred to as the RTMA group) made comments to the FCC during the 1949-1950 color hearings, suggesting a series of tests for color television systems.

The NTSC/RTMA committee also set up an ad hoc group to study the contemporary state-of-the-art. This ad hoc group had access to the engineering community through publication in the IRE "Proceedings" (Dr. A. Goldsmith, editor). From the work of the ad hoc group came the broad ideas of using the 1941 black-and-white standard for the brightness information and adding color information using subcarriers.

With the release of the FCC notice on June 11, 1951, the chairman of the committee recommended that NTSC-2 be reorganized as a group to achieve the "optimum standard for commercial color television." This reorganized NTSC-2 met 26 times between June 18, 1951 and September 1, 1953. The chairman of the second NTSC was, again, Dr. W.R.G. Baker.

NTSC-2 had a main committee of about 40 members with 10 panels or working groups. The panels and chairpersons were:

Panel 11 Subjective Aspects of Color, Dr. A. N. Goldsmith  
 Panel 11-A Color Transcription, Dr. A. N. Goldsmith  
 Panel 12 Color System Analysis, Donald G. Fink  
 Panel 13 Color Video Standard, A. V. Loughren  
 Panel 14 Color Synchronizing Standard, D. E. Harnett  
 Panel 15 Receiver Compatibility, Rinaldo DeCola  
 Panel 16 Field Testing, Knox McIlwain  
 Panel 17 Broadcast System, R. E. Shelby  
 Panel 18 Co-ordination, D. R. Smith  
 Panel 19 Definitions, Dr. R. M. Browie

The writing of the NTSC color TV system came from the work of Panels 13 and 14, with Panel 13 doing the video and Panel 14 providing the synchronizing pulses.

### 5.4 Petition to the FCC

On February 2, 1953, NTSC-2 had approved for publication a recommendation for transmission standards for color television. Like many committees, the second NTSC had difficulties finishing its work in a timely manner. Impatient with the delays, RCA and NBC let it be known that they would file a Petition for Rule Making with the FCC if the NTSC did not act.

At the meeting on June 24, 1953, the committee was aware that RCA was planning to file a Petition for Rule Making. Still, the NTSC did not act. The next day, June 25, 1953, RCA and NBC filed a Petition for Rule Making (known as the RCA Red Book). The RCA-NBC color television system was to become, in fact, the NTSC-2 approved recommendation.

On July 8, 1953, Rosel H. Hyde, chairman of the FCC, wrote to Dr. Baker of NTSC advising that RCA and NBC had filed a petition and asking for the results of the NTSC field testing. Chairman Hyde ended his letter with the following: "Your prompt reply advising the Commission of your organization's plans would be greatly appreciated."

At the full NTSC meeting of July 21, 1953, a motion was passed sending to the FCC a petition "for the adoption of transmission standards for color television." The motion was made by D. B. Smith (Philco) and seconded by Dr. Peter Goldmark (CBS). The NTSC petition was filed with the FCC on July 23, 1953.

### 5.5 FCC action

In response to the Petitions for Rule Making, the FCC issued a Notice of Proposed Rule Making on August 7, 1953. On December 17, 1953, the FCC adopted the NTSC Recommendation for Transmission Standards for Color Television. Regular service to the public with the NTSC color television transmission system began on January 23, 1954.

### 5.6 Final meeting

NTSC-2 held its final meeting on September 1, 1953 and issued a final report. A copy of the NTSC final report can be found in the library of the National Association of Broadcasters.

### 5.7 NTSC information

The final report of the second NTSC was 17 volumes of bound mimeographed pages of which only a few hundred copies were printed. It was apparently thought there was no real need for wide distribution because the work of the committee had been well covered in the electronic industry press during 1951, 1952, and 1953.

When RCA and NBC filed their Petition for Rule Making (June 25, 1953), they had several thousand copies of their petition printed, commonly known as the RCA Red Book. In 1955, Donald G. Fink published a book on the 2nd NTSC standard.

Since few people had access to the final report of the 2nd NTSC, over the years, the RCA Red Book and Fink's 1955 book became the design references for many engineers.

### 5.8 Transmission standard

The 1953 NTSC Recommendation for Transmission Standards for Color Television was just what the name implied, a transmission standard. There are different video signals that, when filtered by passing through a TV transmitter, will produce an NTSC color transmission signal.

### 5.9 Technology change

The second NTSC optimized the color resolution within the available 4.2 MHz bandwidth by specifying different bandwidths for the modulated I and Q components. The I signal, which corresponds to the eye's greatest color resolution sensitivity, was allocated a wider bandwidth than the Q signal. This was accomplished, when the two signals were placed in quadrature, by limiting the bandwidth of the Q signal and allowing amplitude, as opposed to quadrature, recovery of the lower sideband of the I signal. When added to the lower spectrum of the I signal recovered through the quadrature demodulation process, this yielded a wider bandwidth channel for the I signal.

Early NTSC receivers incorporated the circuitry for wideband recovery. It was quickly found, however, that adequate picture performance and reduced receiver complexity could be achieved with the narrowband recovery of both I and Q provided by quadrature demodulation alone. Because all modern

receivers utilize this technique, there is now no disadvantage in transmitting equal-bandwidth color-difference signals. Equipment that generates equal-bandwidth color-difference signals (either B-Y and R-Y or I and Q) has been in regular use in studio practice for a number of years (see 4.3).

**5.10 EIA efforts**

The Electronic Industries Association (EIA) published Electrical Performance Standards — Monochrome Television Studio Facilities (RS 170) in November 1957. The EIA modernized the sync signal in the circulated but unpublished drawing, Color Television Studio Picture Line Amplifier Output (Tentative Standard) in November 1977. This drawing was to have been included in a revised document, RS-170A, but the document was never completed. The drawing standardized the phase relationship between sync and burst (zero SC-H phase). The color video encoding of the signal was not addressed by the RS-170A drawing.

**Annex A (informative)  
Bibliography**

- SMPTTE 170M, Television—Composite Analog Video Signal — NTSC for Studio Applications
- SMPTTE RP 145-1987 — Color Monitor Colorimetry
- SMPTTE EG 1-1990, Alignment Color Bar Test Signal for Television Picture Monitors

**Annex B (informative)**

**Appendix A of the 1953 final report of the National Television System Committee**  
NOTE — This annex and its associated figures are a transcription of Appendix A of the NTSC 1953 Final Report.

Appendix A  
NATIONAL TELEVISION SYSTEM COMMITTEE SIGNAL SPECIFICATION

Approved by Panel 13, July 8, 1953 and the National Television System Committee July 21, 1953

**1. General Specifications**

**A. Channel**

The color television signal and its accompanying sound signal shall be transmitted within a 6 megacycle channel.

**B. Picture Signal Frequency**

**5.11 SMPTE color monitor standard**

The Society of Motion Picture and Television Engineers (SMPTTE) Committee on Television Technology Working Group on Studio Monitor Colorimetry provided a new specification for professional video monitor phosphors in RP 145-1987 (commonly known as the SMPTTE C set or the Conrac phosphors). Many manufacturers modified their camera designs to reflect the change in professional display phosphors.

**5.12 SMPTE NTSC video standard**

The SMPTTE Committee on Television Technology Working Group on Studio Video Standards (WG-SVS) was assigned the task of writing a modern NTSC color video standard in April 1988. That work (SMPTTE 170M, Standard for Television — Composite Analog Video Signal — NTSC for Studio Applications) was completed in 1992.

Fink, Donald G. (ed.), Color Television Standards, Selected Papers and Records of the NTSC, McGraw-Hill, New York, 1955

National Television Systems Committee 1953, Recommendations for Transmission Standards for Color Television

The aspect ratio of the scanned image shall be four units horizontally to three units vertically.

**F. Scanning and Synchronization**

1. The color picture signal shall correspond to the scanning of the image at uniform velocities from left to right and from top to bottom with 525 lines per frame interlaced 2:1.
2. The horizontal scanning frequency shall be 21455 times the color subcarrier frequency; this corresponds nominally to 15,750 cycles per second (with an actual value of 15,734.264 ± 0.047 cycles per second). The vertical scanning frequency is 21525 times the horizontal scanning frequency; this corresponds nominally to 60 cycles per second (the actual value is 59.94 cycles per second).
3. The color television signal shall consist of color picture signals and synchronizing signals, transmitted successively and in different amplitude ranges except where the chrominance penetrates the synchronizing region, and the burst penetrates the picture region.
4. The horizontal, vertical, and color synchronizing signals shall be those specified in Figure 1, as modified by vestigial sideband transmission specified in Figure 2 and by the delay characteristic specified in III.B.

**G. Out-of-Channel Radiation**

The field strength measured at any frequency beyond the limits of the assigned channel shall be at least 60 db below the peak picture level.

**II. Sound**

**A. Sound Signal Frequency**

The frequency of the unmodulated sound carrier shall be 4.5 Mc ± 1000 cycles above the frequency actually in use for the picture carrier.

**B. Sound Signal Characteristics**

The sound transmission shall be by frequency modulation, with maximum deviation of ± 25 kilocycles, and with preemphasis in accordance with a 75 microsecond time constant.

**C. Power Ratio**

The effective radiated power of the aural-signal transmitter shall be not less than 50 per cent nor more than 70 per cent of the peak power of the visual signal transmitter.

**III. The Complete Color Picture Signal**

**A. General Specifications**

The color picture signal shall correspond to a luminance (brightness) component transmitted as amplitude modulation of the picture carrier and a simultaneous pair of chrominance (coloring) components transmitted as the amplitude modulation sidebands of a pair of suppressed subcarriers in quadrature having the common frequency relative to the picture carrier of + 3.579545 Mc ± 0.0003 per

cent with a maximum rate of change not to exceed 1/10 cycle per sec per sec.

**B. Delay Specification**

A sine wave, introduced at those terminals of the transmitter which are normally fed the color picture signal, shall produce a radiated signal having an envelope delay, relative to the average envelope delay between 0.05 and 0.20 Mc, of zero microsecond up to a frequency of 3.0 Mc; and then linearly decreasing to 4.18 Mc so as to be equal to -0.17 μsec at 3.58 Mc. The tolerance on the envelope delay shall be ± 0.05 μsec. The tolerance shall increase linearly to ± 0.1 μsec, down to 2.1 Mc, and remain at ± 0.1 μsec down to 0.2 Mc\*. The tolerance shall also increase linearly to ± 0.1 μsec at 4.18 Mc.

**C. The Luminance Component**

1. An increase in initial light intensity shall correspond to a decrease in the amplitude of the carrier envelope (negative modulation).
2. The blanking level shall be at (75 ± 2.5) per cent of the peak amplitude of the carrier envelope. The reference white (luminance) level shall be (12.5 ± 2.5) per cent of the peak carrier amplitude. The reference black level shall be separated from the blanking level by the setup interval, which shall be (7.5 ± 2.5) per cent of the video range from the blanking level to the reference white level.
3. The overall attenuation versus frequency of the luminance signal shall not exceed the value specified by the FCC for black and white transmission.

**D. Equation of Complete Color Signal**

1. The color picture signal has the following composition:

$$E_M = E_Y + [E_G \sin(\omega t + 33^\circ) + E_R \cos(\omega t + 33^\circ)]$$

where

$$E_G = 0.41 (E_B - E_Y) + 0.48 (E_R - E_Y)$$

$$E_R = -0.27 (E_B - E_Y) + 0.74 (E_R - E_Y)$$

$$E_Y = 0.30 E_R + 0.59 E_G + 0.11 E_B$$

The phase reference in the above equation is the phase of the (color burst + 180°), as shown in Figure 3. The burst corresponds to amplitude modulation of a continuous sine wave.

Notes: For color-difference frequencies below 500 Kc, the signal can be represented by

$$E_M = E_Y + \left\{ \frac{1}{1.14} \left[ \frac{1}{1.78} (E_G - E_Y) \sin \omega t + (E_R - E_Y) \cos \omega t \right] \right\}$$

In these expressions the symbols have the following significance:

\*Tolerances for the interval of 0.0 to 0.2 Mc should not be specified in the present state of the art.

$E_v$  is the total video voltage, corresponding to the scanning of a particular picture element, applied to the modulator of the picture transmitter.

$E_v'$  is the gamma-corrected voltage of the monochrome (black-and-white) portion of the color picture signal corresponding to the given picture element.

$E_r$ ,  $E_g$ , and  $E_b$  are the gamma-corrected voltages corresponding to red, green, and blue signals during the scanning of the given picture element.

The gamma corrected voltages  $E_r$ ,  $E_g$ , and  $E_b$  are suitable for a color picture tube having primary colors with the following chromaticities in the CIE system of specification:

	x	y
Red (R)	0.67	0.33
Green (G)	0.21	0.71
Blue (B)	0.14	0.08

and having a transfer gradient (gamma exponent) of 2.2\*\* associated with each primary color. The voltages  $E_v'$ ,  $E_r$ ,  $E_g$ , and  $E_b$  may be respectively of the form  $ER^n$ ,  $EG^n$ , and  $EB^n$  although other forms may be used with advances in the state of the art.

$E_o'$  and  $E_i'$  are the amplitudes of two orthogonal components of the chrominance signal corresponding respectively to narrow-band and wide-band axes, as specified in paragraph D.5.

The angular frequency  $\omega$  is  $2\pi$  times the frequency of the chrominance subcarrier.

The portion of each expression between brackets represents the chrominance subcarrier signal which carries the chrominance information.

2. The chrominance signal is so proportioned that it vanishes for the chromaticity of CIE illuminant C ( $x = 0.310$ ,  $y = 0.316$ ).

\*\*Forming of the high frequency portion of the monochrome signal in a different manner is permissible and may in fact be desirable in order to improve the sharpness on saturated colors.

\*\*At the present state of the art it is considered inadvisable to set a tolerance on the value of gamma and correspondingly this portion of the specification will not be enforced.

3.  $E_v'$ ,  $E_o'$ ,  $E_i'$  and the components of these signals shall match each other in time to 0.05 usecs.

4. A sine wave of 3.58 Mc introduced at those terminals of the transmitter which are normally fed the color picture signal shall produce a radiated signal having an amplitude, (as measured with a diode on the R.F. transmission line supplying power to the antenna) which is down (6 ± 2) db with respect to a radiated signal produced by a sine wave of 200 kc. In addition, the amplitude of the radiated signal shall not vary by more than ± 2 db between the modulating frequencies of 2.1 and 4.18 Mc.

5. The equivalent bandwidths assigned prior to modulation to the color-difference signals  $E_o'$  and  $E_i'$  are given by Table 1.

Table 1

Q-channel bandwidth	I-channel bandwidth
at 400 kc less than 2 db down	at 1.3 mc less than 2 db down
at 500 kc less than 6 db down	at 3.6 mc at least 20 db down
at 600 kc at least 6 db down	

6. The angles of the subcarrier measured with respect to the burst phase, when reproducing saturated primaries and their complements at 75 per cent of full amplitude, shall be within ± 10° and their amplitudes shall be within ± 20 per cent of the values specified above. The ratios of the measured amplitudes of the subcarrier to the luminance signal for the same saturated primaries and their complements shall fall between the limits of 0.8 and 1.2 of the values specified for their ratios. Closer tolerances may prove to be practicable and desirable with advance in the art.

# TELEVISION SYNCHRONIZING WAVEFORM

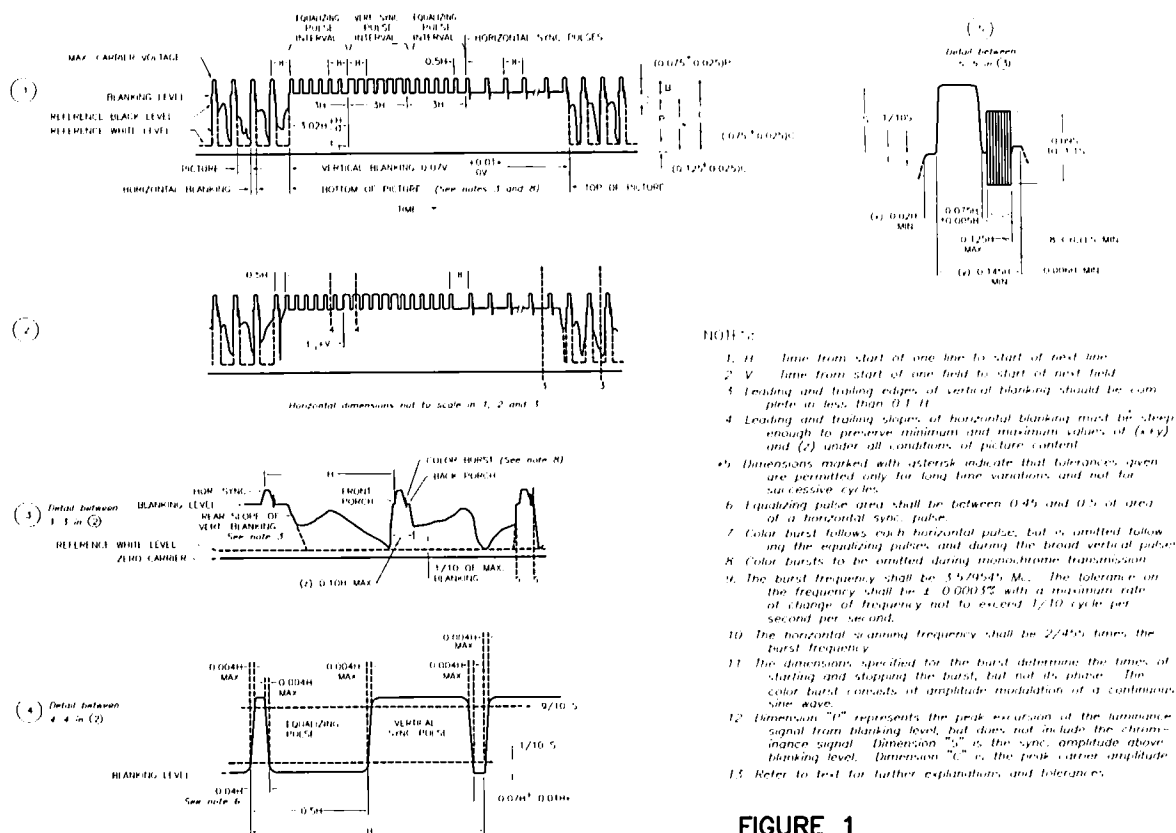
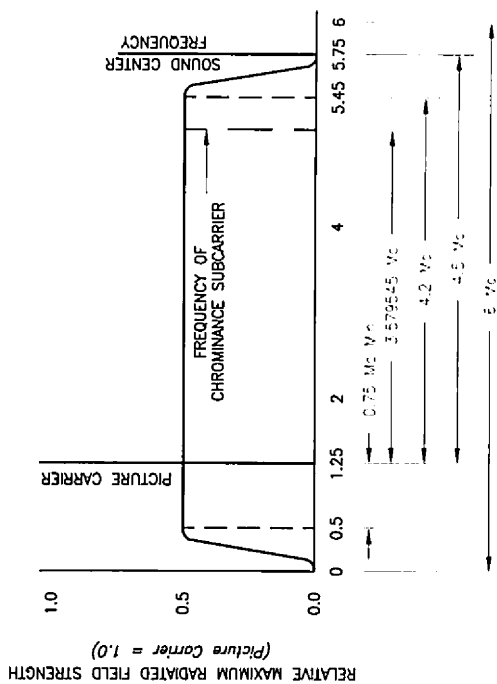

FIGURE 1

IDEALIZED PICTURE TRANSMISSION  
AMPLITUDE CHARACTERISTIC



Note: Not drawn to scale Figure 2

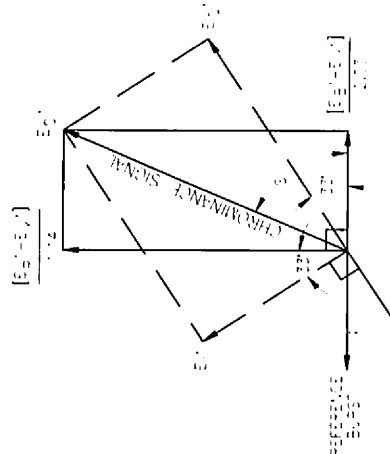

Figure 3